

# LED MIRROR INSTALLATION INSTRUCTIONS

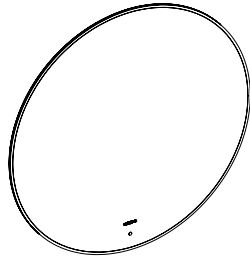

MLR1515

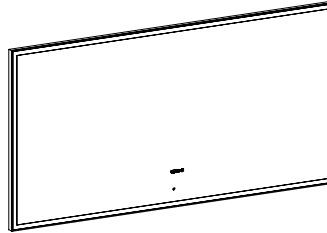

MLY2010

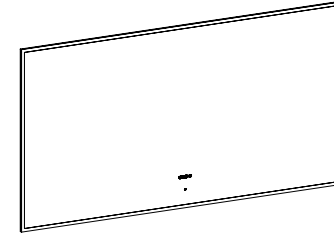

MLE2010

Please read these instructions carefully before installation.  
Installation should be carried out by a qualified electrician.  
Please note that installation of the product is an acceptance that the product is free from visible defect.

## GENERAL

- THIS PRODUCT CONFORMS TO UK SAFETY STANDARDS AND MUST BE INSTALLED IN ACCORDANCE WITH CURRENT IEE WIRING REGULATIONS AND BUILDING REGULATIONS (PART P). THIS PRODUCT MUST BE EARTHED, AND SHOULD NOT BE CONNECTED TO AN UNEARTHED CIRCUIT.
- IF THERE ARE ONLY TWO WIRES COMING FROM YOUR POWER SUPPLY IT MEANS THAT THIS FITTING CAN BE WIRED TO AN UNEARTHED CIRCUIT.
- ENSURE THAT CONNECTIONS ARE TURNED OFF AT THE CONSUMER UNIT OR FUSE BOARD BEFORE INSTALLING OR CARRYING OUT ANY MAINTENANCE.
- THIS PRODUCT IS FOR IN DOOR USE ONLY.
- THIS PRODUCT IS IP44 RATED AND CAN BE INSTALLED IN BATHROOM ZONE 2 (AS DEFINED BY THE IEE WIRING REGULATIONS) AND BEYOND. SEE BATHROOM DIAGRAM BELOW.
- REPLACE FAILED LAMPS IMMEDIATELY. ALLOW THE GLASS, LAMP AND FITTING TO COOL BEFORE REPLACING THE LAMP.

## IEE Bathroom Zones Diagram

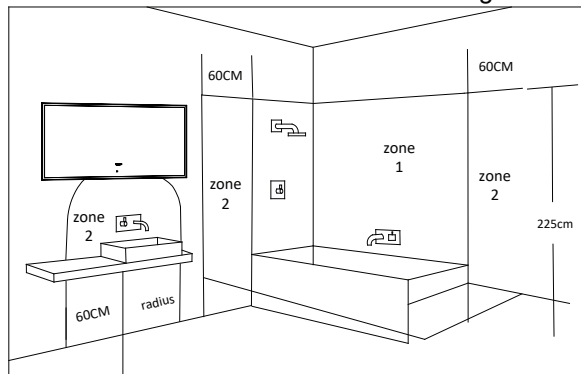

OUTSIDE ZONES

## IMPORTANT

- When working at heights, please use a suitable platform to work from.
- Please note: For new installations, check for any electrical cables or pipe work (gas/water) in the vicinity of the intended mounting point before proceeding with the installation.
- Ensure that the fixing location is able to take the weight of the complete fitting. Wear suitable eye protection when drilling. Be careful when using power tools near water.

Do NOT strike mirror glass with hard or pointed items. It is recommended that the product is cleaned with a soft, dry, non abrasive cloth. Do NOT use cleaning agents or abrasive materials on any type of finished surface. Do NOT allow moisture to come into contact with the electrical components.

## Compliance

This product complies with the following safety standards:  
BS EN 60598-1: 2008+A11: 2009, EN60598-2-1: 1989

## Wiring

This product is manufactured to class I category and requires an earth connection

## COLOUR CODING:

- L - Live = Brown
- Neutral = Blue
- ⊖ - Earth = Green & Yellow

# LED MIRROR INSTALLATION INSTRUCTIONS



## Installation procedure

1. Open the carton and make sure all the parts listed below are present

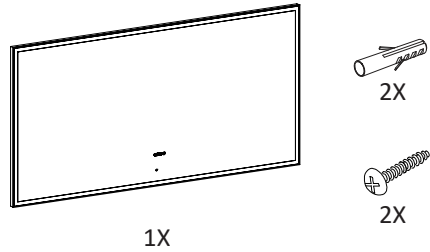

2. Mark a desired height of the mirror. Drill the required holes and insert the wall plugs.  
Note: Wall plugs supplied are only suitable for solid stone/brick walls. Please ensure the screws are fully tight. The mirror can be mounted either portrait or landscape.

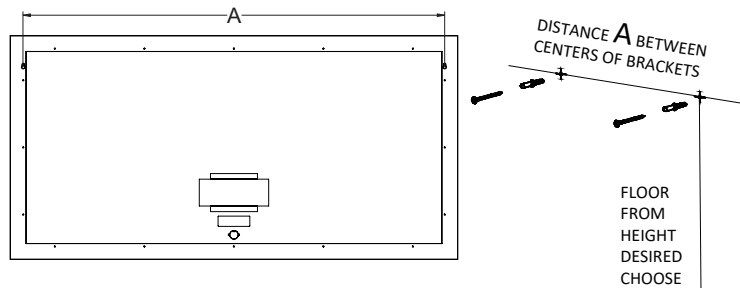

3. Make the electrical connections ensuring first that the electrical supply has been turned off. This mirror is a class 1 product and requires an earth connection. It should be installed in accordance with the latest IEE regulations.

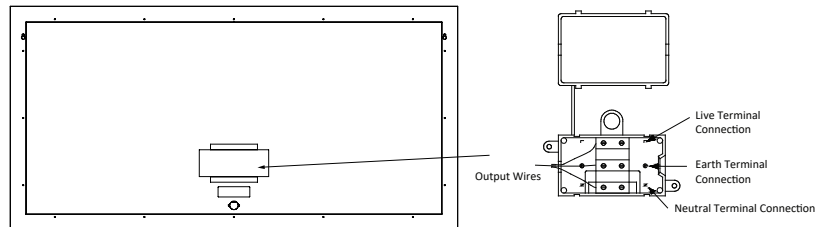

4. Hang the mirror onto the wall.

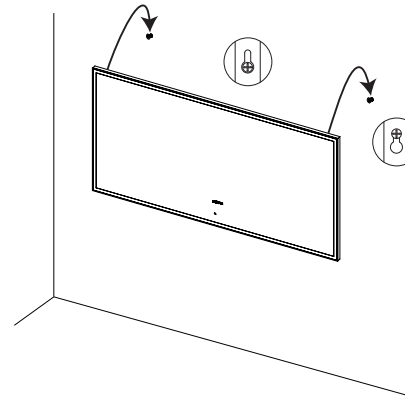

5. Clock + Human-body detection Switch Instructions

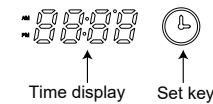

1. Short touch to set time system to 12 hours format or 24 hours format.
2. Long press until the numbers of hour on the clock start to flash
3. Short touch until the correct time is reached.
4. Long press until the numbers of minute on the clock start to flash
5. Short touch until the correct time is reached
6. Long press to save the correct time and it is done.

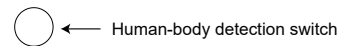

**Functions:**  
Power on to preheat for 30 seconds, and then start the human-body detection function. When human-body or objects moves in the detection range, LED lamp will turn on. When human-body leaves the detection range or no motion detected in the detection range, LED lamp will turn off after delay time.